





SUBMINISTRAMENT D'AIGUA POTABLE

-  PERICÓ DE 57X57X125 cm.
-  VALVULA DE COMPORTA MANUAL EMBRIDADA
-  XARXA D'AIGUA POTABLE TUB DE PE DE DENSITAT ALTA
-  XARXA DE REG
-  HIDRANT



DETALL RASA CANALITZACIÓ D'AIGUA

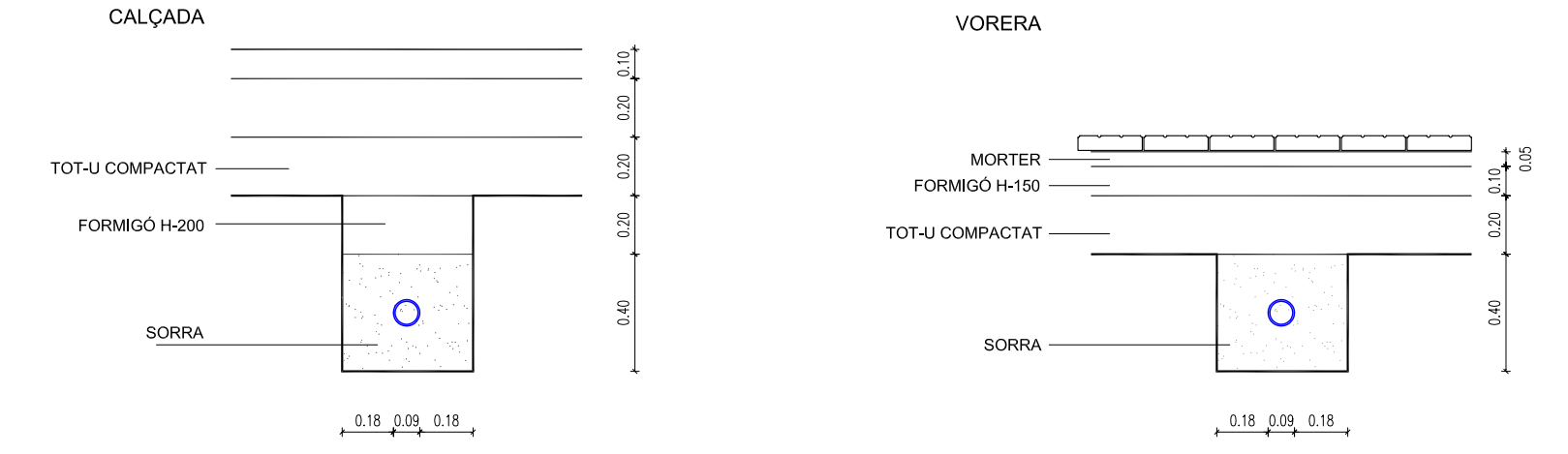

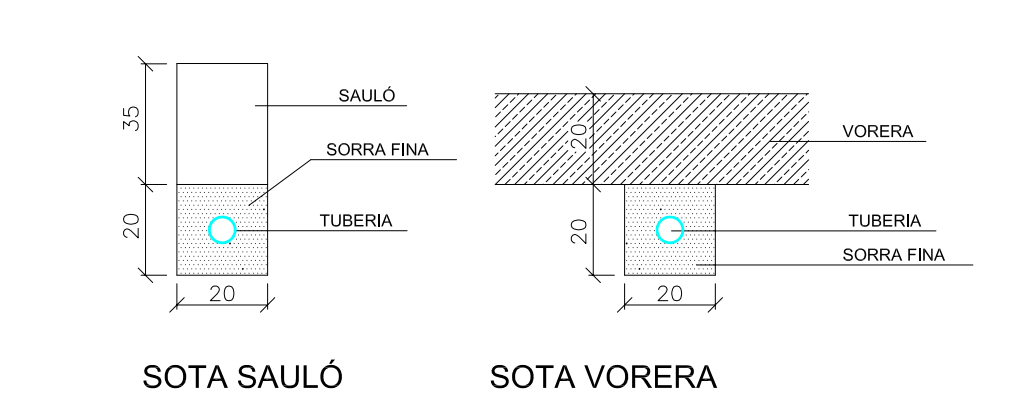
DETALL RASA REG



GAS NATURAL

-  CANONADA A COL·LOCAR PER L'EMPRESA GAS NATURAL
-  ESCOMESA INDIVIDUAL

DETALL RASA

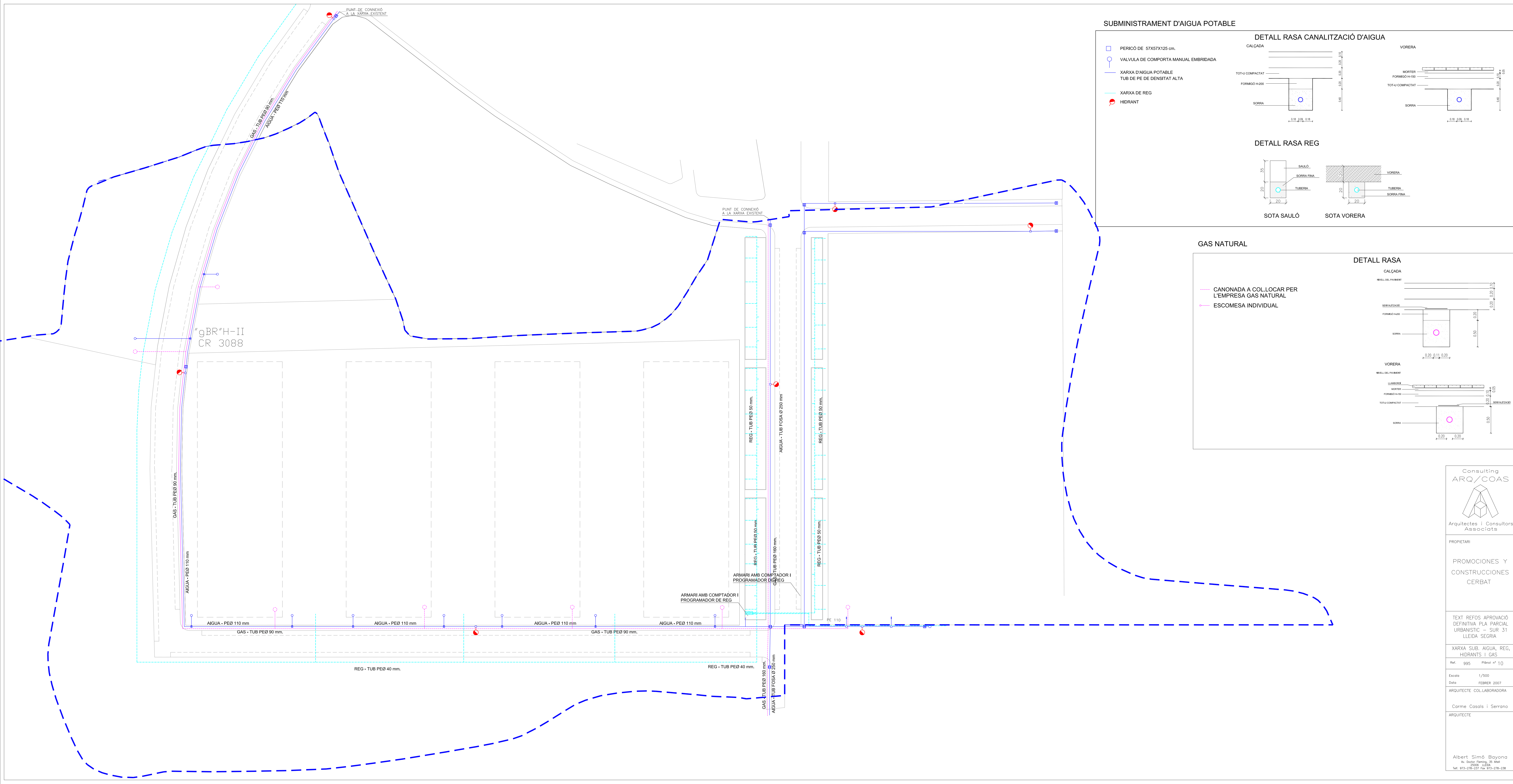
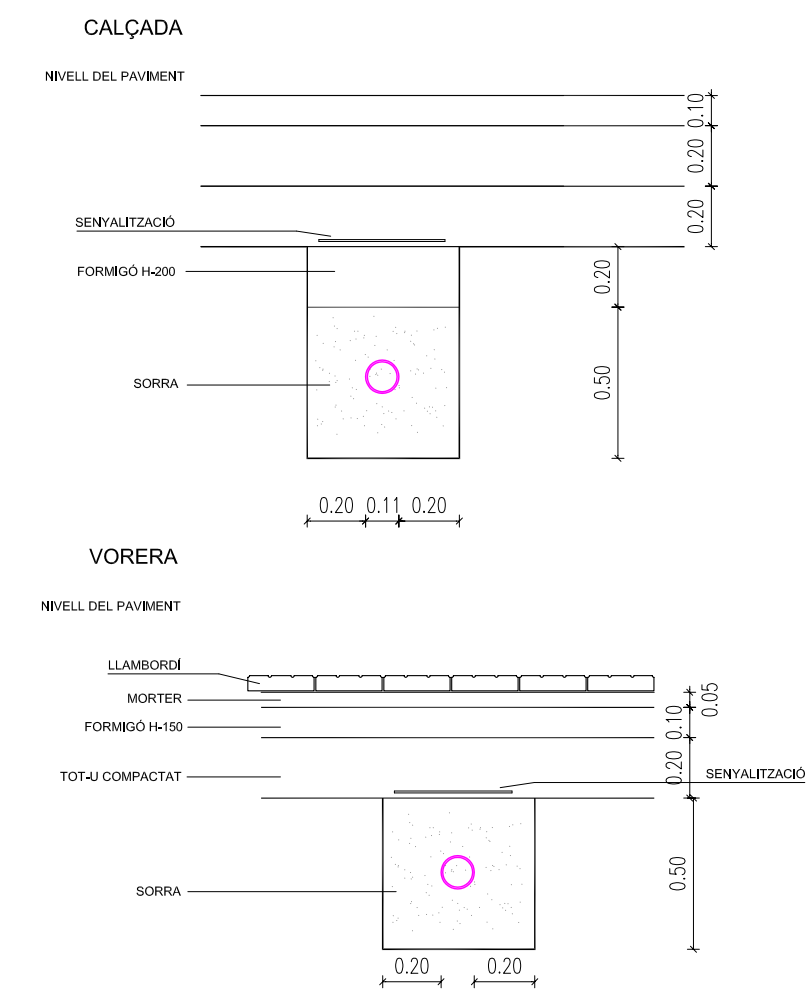

Consulting
ARQ/COAS

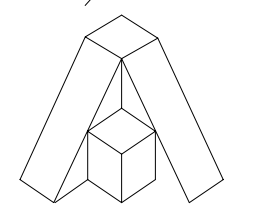

Arquitectes i Consultors
Associats

PROPIETARI
PROMOCIONES Y
CONSTRUCCIONES
CERBAT

TEXT REPOS APROVACIÓ
DEFINITIVA PLA PARCIAL
URBANÍSTIC - SUR 31
LLEIDA SEGRIA

XARXA SUB. AIGUA, REG,
HIDRANTS I GAS

Ref. 995 Plànol nº 10

Escala 1/500
Data FEBRER 2007

ARQUITECTE COL·LABORADORA
Carme Casals i Serrano
ARQUITECTE

Albert Simó Bayona
Ar. Doctor Ferragut, 35 4rt
08005 LLEIDA
Telf. 973-278-237 Fax 973-278-238